

Owner Installation
Manual for
AW631, 831, 1231, 1531
AIR/WATER HEAT PUMPS

(SD526750 Issue 10)
04/11/08

Contents

AIR/WATER HEAT PUMPS FOR SWIMMING POOLS	3
HOW THE HEAT PUMP WORKS	4
INSTALLATION	5
1.SITING	5
2.AIR FLOW	6
3.PLUMBING	7
RECOMMENDED PLUMBING SCHEMATIC	9
4. DETERMINING WATER FLOW	10
5.ELECTRICAL (MACHINE WIRING AND SUPPLY).	11
ELECTRICAL CIRCUIT DIAGRAMS	17
CONTROLS AND INDICATION LAMPS	19
HEAT PUMP MALFUNCTION	20
DATA SHEET	21
INSTALLATION DRAWINGS	23
WINTERISING PROCEDURE	27
START UP PROCEDURE AFTER WINTERISATION	28
WARRANTY CONDITIONS.	29
CONTACTING CALOREX	30

AIR/WATER HEAT PUMPS FOR SWIMMING POOLS

MODELS AW631, 831,1231, 1531

The Calorex '31' range of air/water heat pumps is for swimming pool applications and consists of 4 models. Heat pumps in this manual are designed to heat pool water and spas within the range of 10°C to 40°C. Standard units are suitable for outdoor pools operating in ambient temperatures from 7°C to 40°C. Reverse Cycle Defrost models are available with operation down to -15°C, these machines are suitable for heating indoor pools or spas all year round. The water heat exchanger is a full flow type, manufactured from titanium, which is a highly corrosion resistant material. The heat pumps are suitable for use in fresh water and salt water pools. The compressors fitted in the heat pumps are the scroll type and are known for quiet running. With these features the heat pump is designed to have a long, trouble free life.

All units have integral safety devices to protect the heat pump from internal and external faults. Indicator lamps indicate operating mode. An adjustable digital thermostat controls water temperature. Also a 6 minute cycle time delay is incorporated.

HOW THE HEAT PUMP WORKS

The **CALOREX** Swimming Pool Heat Pump provides thermodynamic heating by means of a vapour compression cycle (similar to that employed in a conventional refrigerator), in addition to operating as an active solar collector.

The **EVAPORATOR** collects heat from the outside ambient air, pre-heated by the sun. With Calorex, swimming pool heat pumps high volumes of outside air are drawn into the unit by the fan and expelled through the evaporator fins. The evaporator has liquid refrigerant passing through it, which is at a considerably lower temperature than the ambient air, therefore the air gives up its heat to the refrigerant, which then vaporizes.

This pre-heated vapour now travels to-

The **COMPRESSOR** where it is compressed and upgraded to a much higher temperature.
The hot vapour now enters -

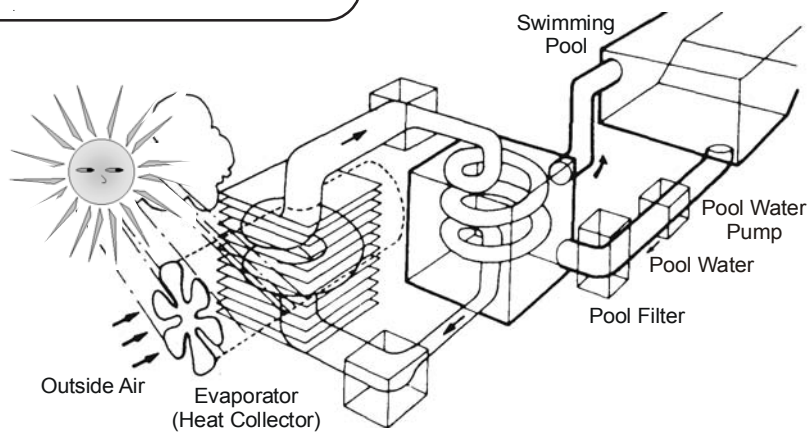

The **EXPANSION DEVICE** and from there, now at low pressure, it is returned to the evaporator and the cycle starts again.

The **CONDENSER** where it is surrounded by the pool water. The heat is given up to the cooler pool water and the now cooler refrigerant returns to its former liquid state but still under high pressure from the compressor. This pressure is released by passing the liquid through -

Coefficient of Performance

The efficiency of a Heat Pump is usually called its 'Coefficient of Performance' - (C.O.P.) which is simply a ratio of heat output to energy input, both being expressed in kW. Thus a Heat Pump absorbing 1 kW of electricity, collecting 4 kW of energy from the air, and delivering 5 kW of heat to the pool water is said to have a C.O.P. of 5:1.

Naturally this ratio will vary according to the temperature of the water and the ambient air.

INSTALLATION

1. SITING

- a Ensure heat pump on site is as ordered, i.e. model, electrical supply and factory fitted options.
- b Inspect unit for damage, in particular inspect the evaporator (finned side) to ensure that it is undamaged. (Minor indentations in the fins do not affect performance). If severely damaged, endorse delivery note in presence of the driver and send a recorded delivery letter to transport company giving details.
- c Protect unit if installation is delayed.
- d Provide a firm level base capable of supporting operational weight of unit; spread load if mounted on timber floor.
- e Ensure water cannot collect under unit, it is recommend that units are installed on plinths 100mm above finished floor level. This also aids condensate drainage.
- f Allow adequate clearance to service panels on unit; recommend 500mm minimum.
- g All Calorex heat pumps are by design as quiet as is practical, however due consideration should be given to siting the heat pump in order to minimise the noise coming from the machine, for example by positioning the machine so that the inlet/outlets are parallel to occupied premises.
- h Ensure loose debris such as leaves, grass cuttings, etc will not block air inlet grilles.
- i Consider protection from extreme weather conditions if installed externally, i.e. lean-to-cover or building.

2. AIR FLOW

Due consideration must be given to air flow, i.e. do not obstruct inlet or outlet and ensure discharge air cannot re-circulate to inlet. (See figure 1)

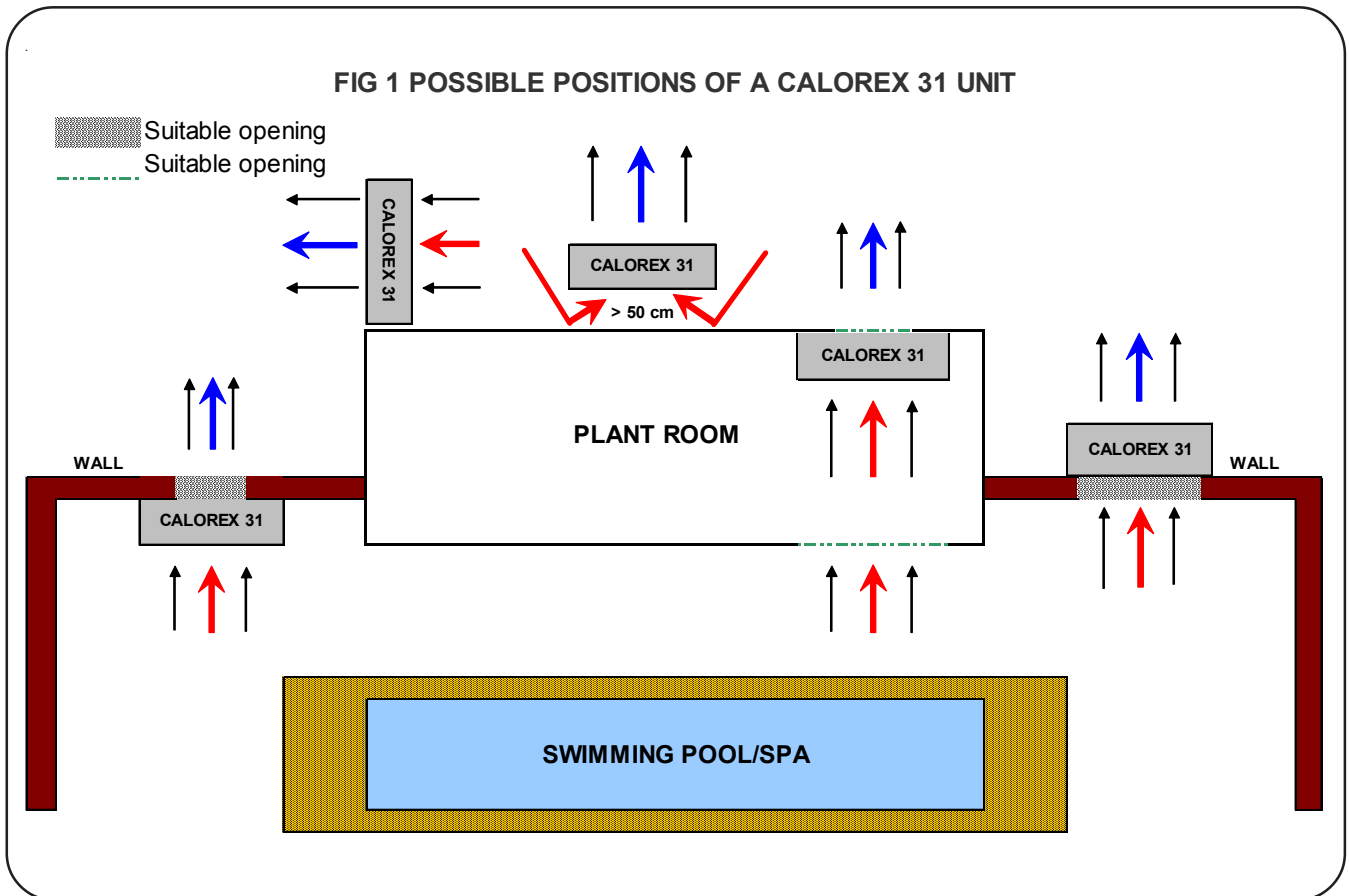

TABLE 1

MODEL	Minimum Free Area m ²	
	Inlet	Discharge
AW 631	0.1648	0.114
AW 831	0.2931	0.114
AW 1231	0.2931	0.114
AW 1531	0.3489	0.114

Required Free Areas to provide air flow to and from heat pumps when installed in an enclosed area or where required to pass air through a wall, etc.

Free area is the available area through which air can pass through a grille or louvres.

Note: If multiple units are installed in an enclosed area then the inlet free areas required for each unit can be added together to form one inlet aperture. BUT discharge from each unit must be kept separate and must not be incorporated into one common duct system.

3. PLUMBING

- a. Calorex '31' range Heat Pumps have water inlet/outlet connections as follows:

All models have 1½" BSP parallel, male threads.

The machine is supplied with bungs fitted in the water connection fittings. These need to be removed before the unit is installed. See Section 4.

- b. The Calorex Pool Heat Pump must be connected after the filter in the return pipe to the pool. If an existing heater is being retained, then the Calorex Heat Pump should be connected between the filter and the other heater. (See figure 4).
- c. Suitable breakable couplings should be installed local to heat pump.
- d. If the heat pump is installed at a lower level than pool water then isolation valves should be fitted.
- e. Drain valve or plug should be fitted to the lower pipe to facilitate drain down in winter period.
- f. Connections on all models are by BSP parallel, male threaded fittings. These should be hand tightened only, otherwise damage may result to the threads of the plastic fittings.
- g. The condensate drain at the base of the unit collects the condensation from the evaporator fins. This should be run away to waste via ¾" domestic waste piping. It is therefore necessary to ensure that the Calorex unit is placed on a level plinth so that the condensate water can run away with adequate fall to waste ie. ½" per foot min and must incorporate a 'u' trap as to not overflow the edges of the drip-tray inside the machine. See figure 3.

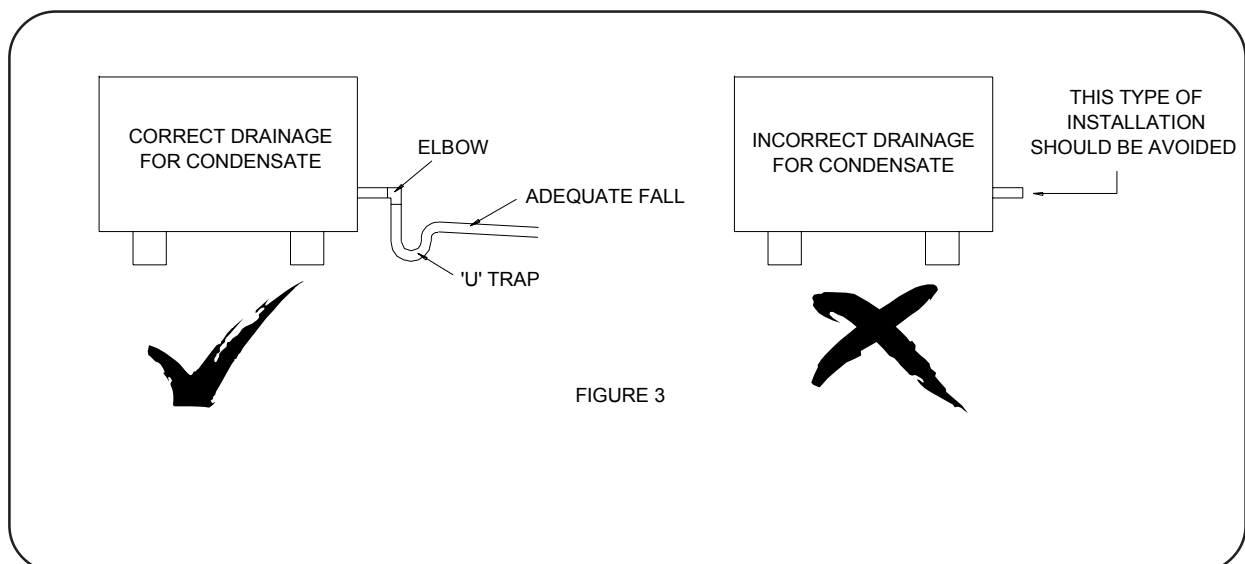

- h. When the pipework installation is complete the pool pump should be switched on and the system tested for leaks. Also check the filter gauge to see that there is not an excessive increase in back pressure. If everything is then working normally the water circulating system is ready to use.
- i. Water circuit to and from unit to be capable of maintaining within specified limits the rate of flow required by heat pump (see data sheet).
- j. All pipework must be adequately supported with allowance for expansion/contraction especially with plastic pipework.
- k. It is recommended that when installing water systems the last connections to be made in the system should be the breakable connections to avoid any stresses on to the unit connections.

IMPORTANT

1. All Pool Purifying Devices and Chemical Injection Systems to be fitted down stream of heat pump unless installation is as per Filter dosing (See figure 4). This includes the practice of dosing chemicals direct into Skimmer Basket, which results in concentrated corrosive liquids passing over metal components.

2. Water quality must be maintained as follows:

pH:	7.4 ± 0.4
Total Alkalinity:	80 - 120 ppm as CaCO ₃
Total Hardness:	100 - 300 ppm as CaCO ₃
Total dissolved solids:	Max. 3000 ppm
Saline Water	Maximum concentration 6% wt/wt
Chlorine - free Cl range	1.0 - 3.0 ppm
Ozone	0.8 - 1.0 ppm
Bromine	2 - 3 ppm
Baquacil	25 - 50 ppm
Aquamatic Ionic Purifier	Maximum 2 ppm Copper
Tam Pure Purifier	Maximum 2 ppm Copper
Sherwood Purifier	Maximum 2 ppm Copper

3. Maximum pressure of water in heat pump circuit should not exceed 3.5kg/cm² (50 psi)

RECOMMENDED PLUMBING SCHEMATIC

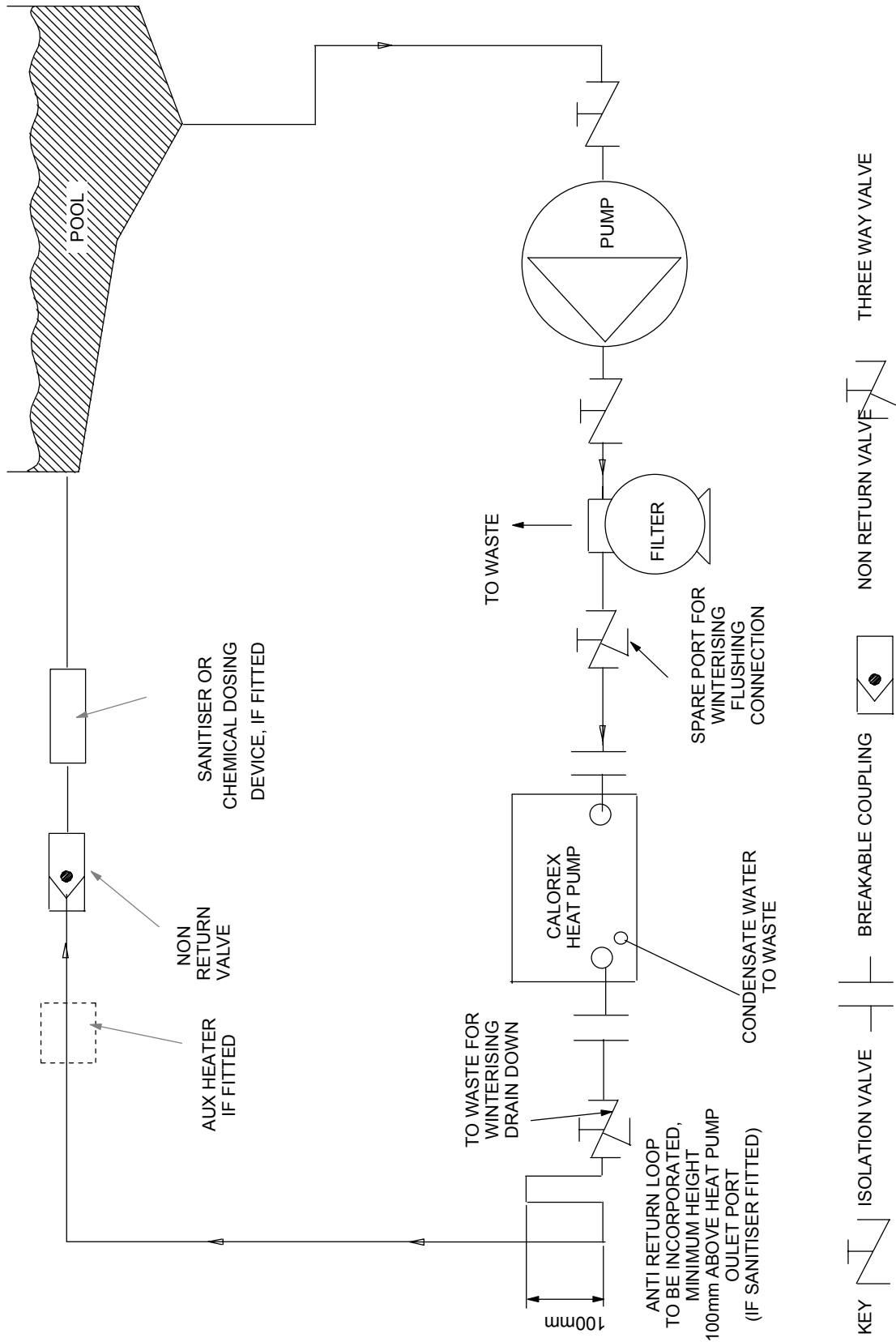









FIGURE 4

4. DETERMINING WATER FLOW

Plumbing.

The machine must be plumbed in as shown, see diagrams below (a tear off label is attached to the machine on delivery).

Adjust the flow rate until the flow light is illuminated, giving the correct flow rate. The “adequate flow” symbol looks like this: 

SYMBOL CHART- ALL MACHINES	
	FLOW LAMP ILLUMINATED, ADEQUATE FLOW
	FLOW LAMP NOT ILLUMINATED, INADEQUATE FLOW
	POOL/SPA
	PUMP
	FILTER
	WATER HEATING AFTER 6 MINUTE DELAY
	REMOVE AND DISPOSE OF LABEL

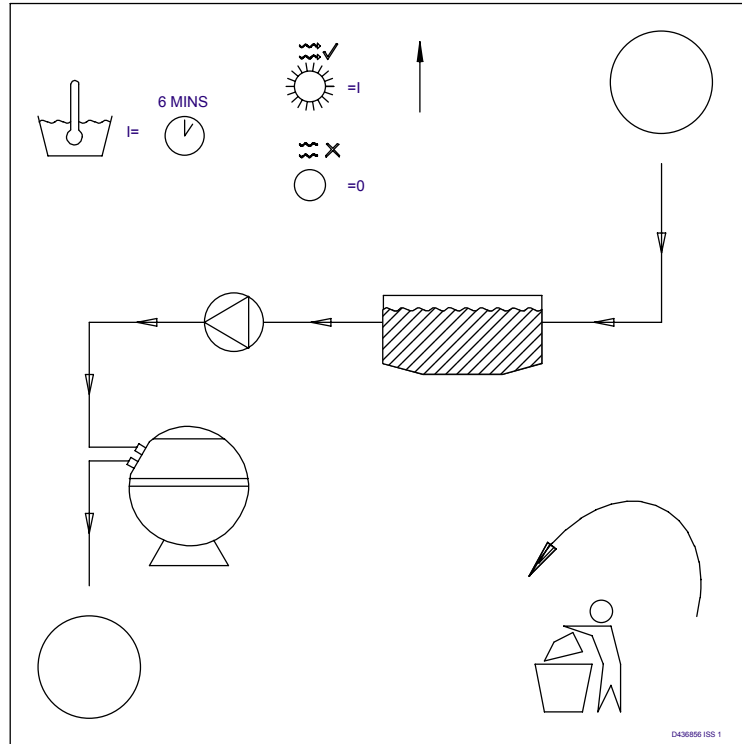

MACHINE LABEL

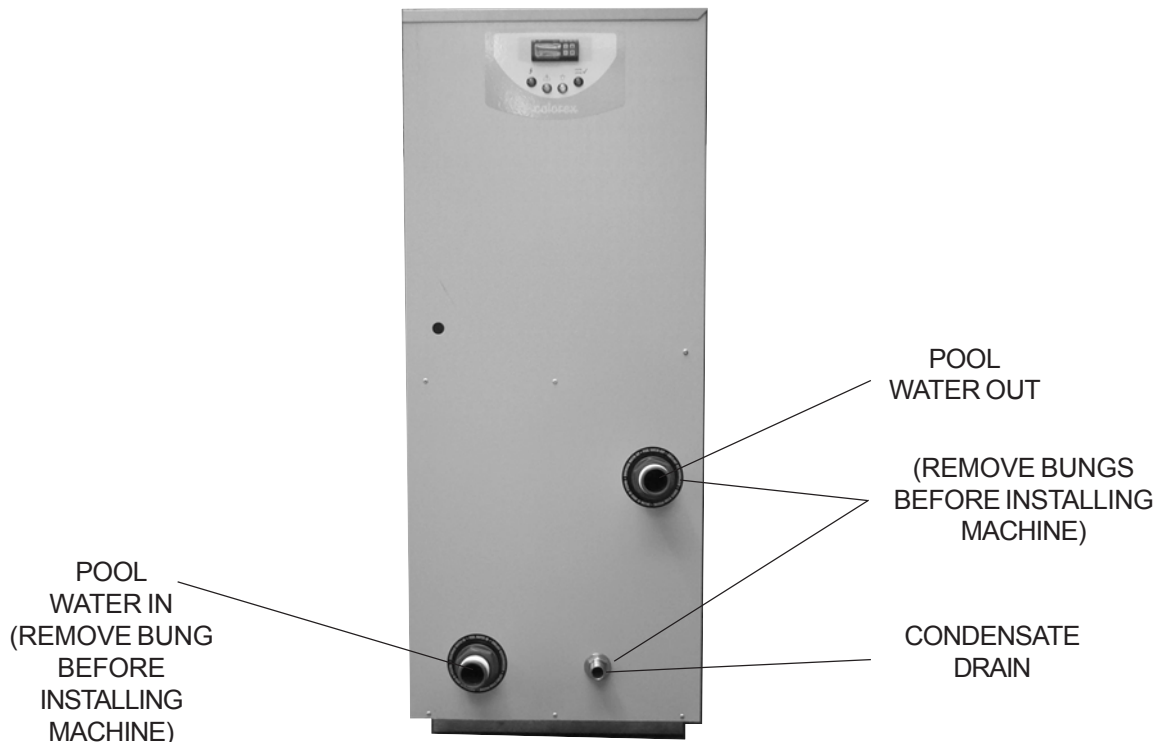

MACHINE SIDE

AW631 AND AW831 FLOW RATE 115 LITRES PER MINUTE
 AW1231 AND AW1531 FLOW RATE 160 LITRES PER MINUTE

5. ELECTRICAL (MACHINE WIRING AND SUPPLY).

SEE FIGURES 5,6,7 AND 8 FOR PREFERRED METHOD

Use of the Calorex Energy Management Controller will enable greater savings to be made because the circulating pump need only run when required and this can be at a time preferred by the customer, i.e. in the Economy 7 period.

All electrical work to be carried out in accordance with I.E.E. standards, latest issue, or local codes of practice as applicable.

The machine should be installed in line with EMC2004/108/EC.

Protected supply to incorporate fuses (Type GU, FAZC) or motor (type C) circuit breakers to specified rating, (see Data Sheet). H.R.C. fuses are recommended. An isolator must be fitted within 2m and in sight of machine.†

All units must be correctly earthed-grounded. An earth leakage trip of the Current operating type (30mA) is recommended to be fitted to all pool electrics.

INCONSISTENT ELECTRICAL SUPPLY

The following limits of operation must not be exceeded if Calorex machines are to be guaranteed either in performance or warranty terms:

	Minimum	Maximum
Voltage		
Single phase machines	207V	253V
Three-phase machines	360V	440V
Cycle frequency	47.5Hz	52.5Hz

N.B. This voltage must be available at the heat pump whilst running.

† Note the isolator must have a minimum of 3mm air gap when turned off.

Three phase units are fitted with a phase protection relay and will not run if phases are connected incorrectly. A red lamp on the phase rotation relay in the electric box is illuminated when the phases are correctly connected.

IMPORTANT:-

The user should be made aware that on all the installations shown by figures 5, 6, 7 and 8 that to work on part of the intallation the supply to all parts of the installation must be isolated.

LOCATION OF ELECTRICAL SUPPLY CONNECTIONS IN 31 RANGE HEAT PUMP

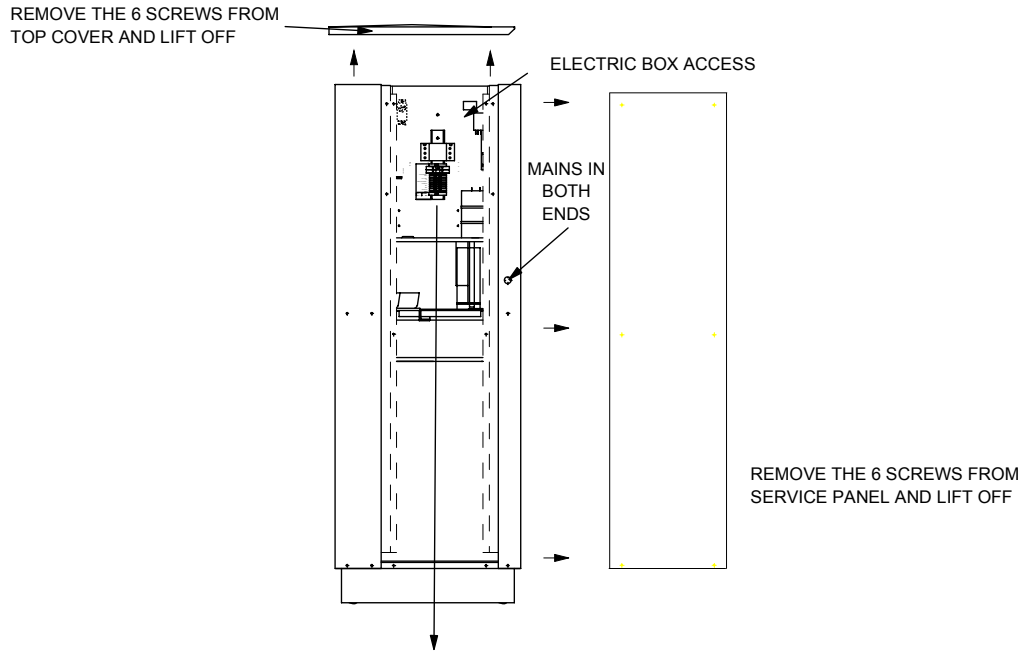
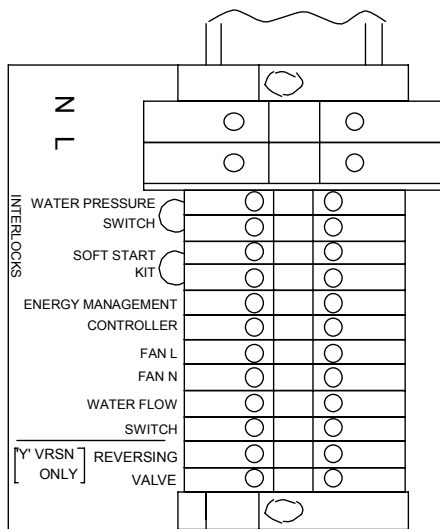

FIGURE 5

1 PHASE 230V ~ 1N 50Hz



3 PHASE 400V ~ 3N 50Hz

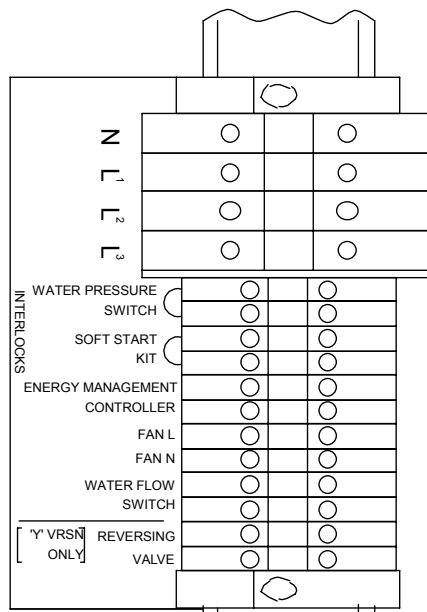

FIGURE 6

RECOMMENDED ELECTRICAL INSTALLATION FOR CALOREX HEAT PUMP (1Ø or 3Ø)
WITH SINGLE PHASE WATER PUMP OF MAXIMUM ¼ H.P. AND
ENERGY MANAGEMENT CONTROLLER

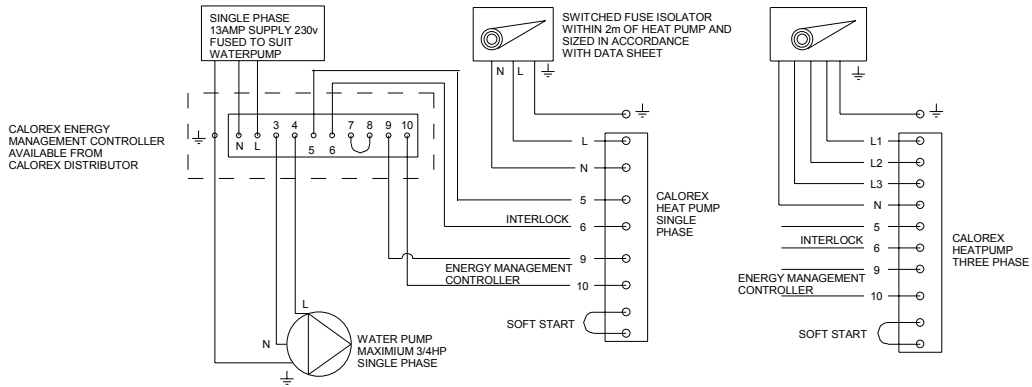

FIGURE 7

RECOMMENDED ELECTRICAL INSTALLATION FOR CALOREX HEAT PUMP (1Ø or 3Ø)
WITH SINGLE PHASE WATER PUMP LARGER THAN ¼ H.P. AND
ENERGY MANAGEMENT CONTROLLER

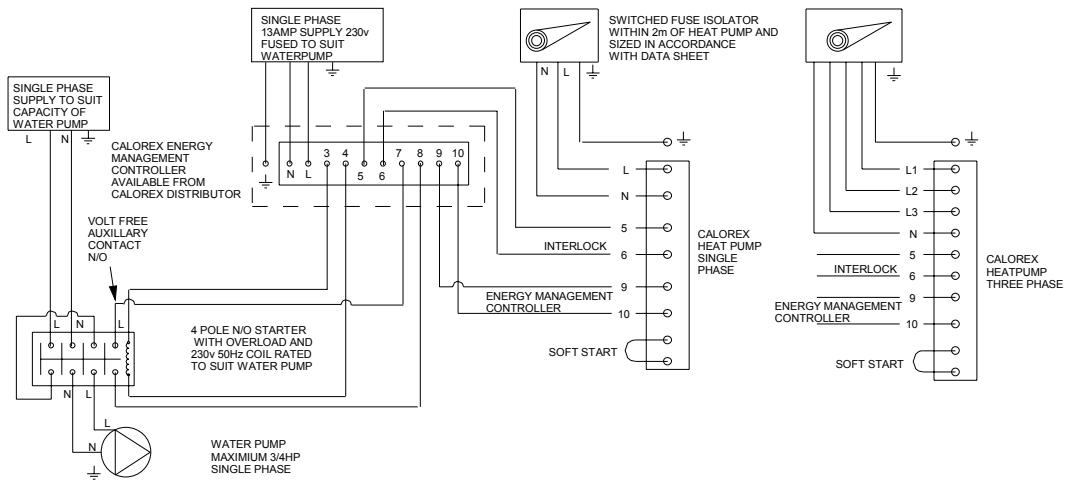

FIGURE 8

RECOMMENDED ELECTRICAL INSTALLATION FOR CALOREX HEAT PUMP (1Ø or 3Ø)
WITH THREE PHASE WATER PUMP AND ENERGY MANAGEMENT CONTROLLER

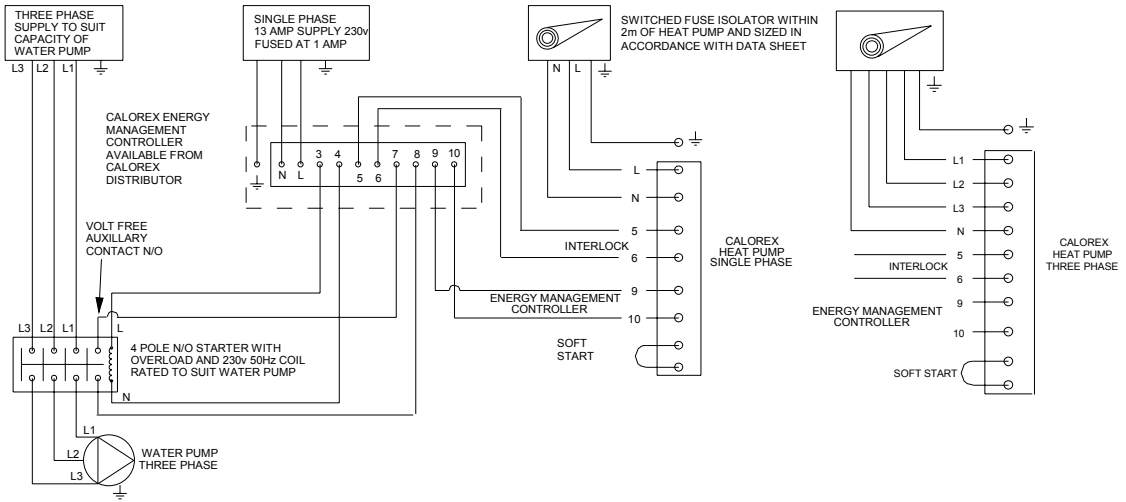

FIGURE 9

RECOMMENDED ELECTRICAL INSTALLATION FOR CALOREX HEAT PUMP (1Ø or 3Ø)
WITH SINGLE PHASE WATER PUMP OF MAXIMUM ¼ H. P

(NOTE: Method shown in Fig 9. is a preferred system due to incorporated starter and interlock)

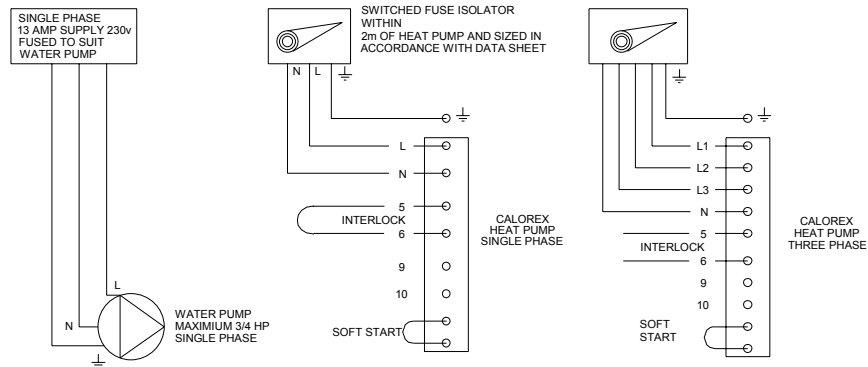

FIGURE 10

RECOMMENDED ELECTRICAL INSTALLATION FOR CALOREX HEAT PUMP (1Ø or 3Ø)
WITH SINGLE PHASE WATER PUMP OF LARGER THAN ¼ H.P.

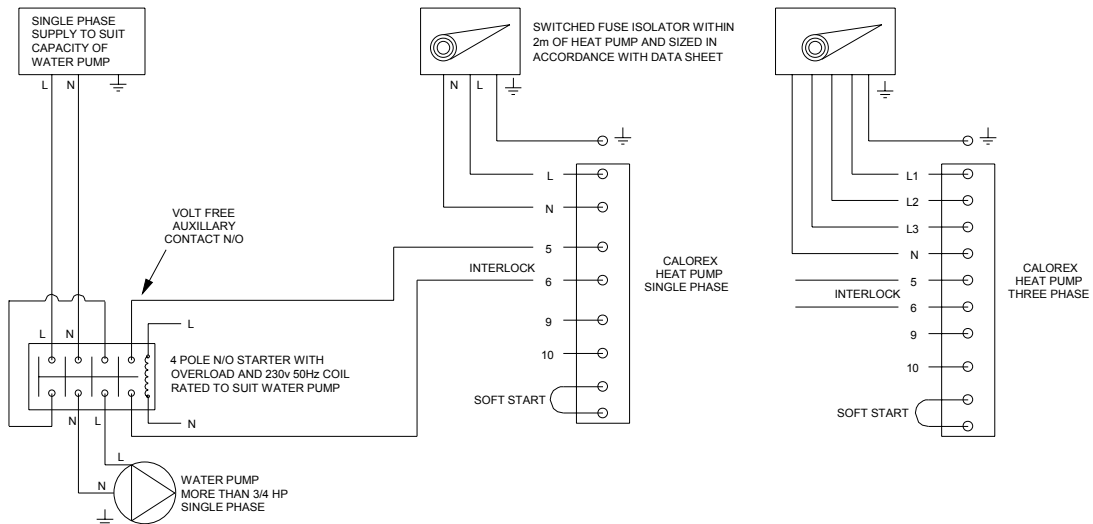
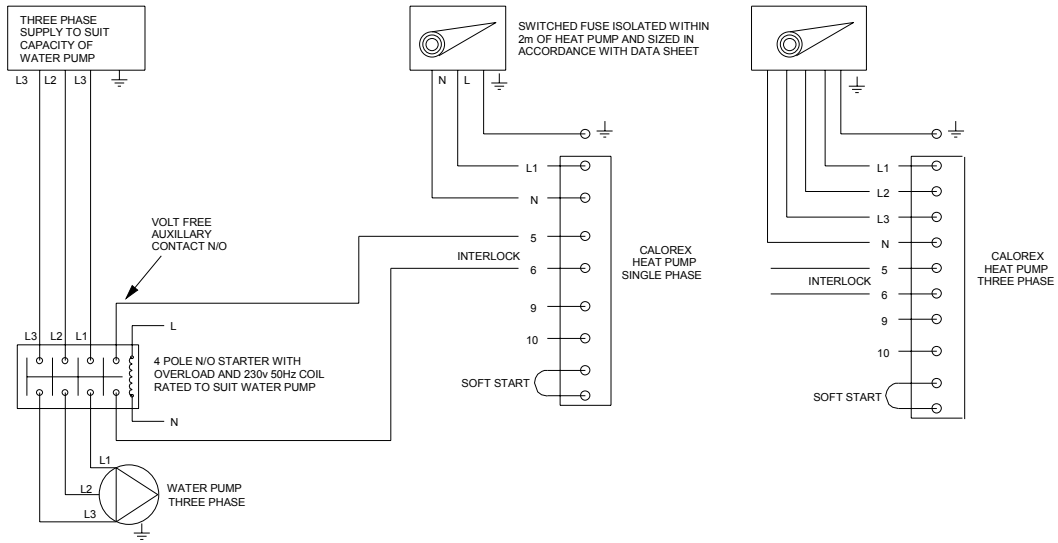

FIGURE 11

RECOMMENDED ELECTRICAL INSTALLATION FOR CALOREX HEAT PUMP(1Ø or 3Ø)
WITH THREE PHASE WATER PUMP



ELECTRICAL CIRCUIT DIAGRAMS

AW631, 831, 1231 AL SINGLE PHASE (230V ~ 1 N 50Hz)

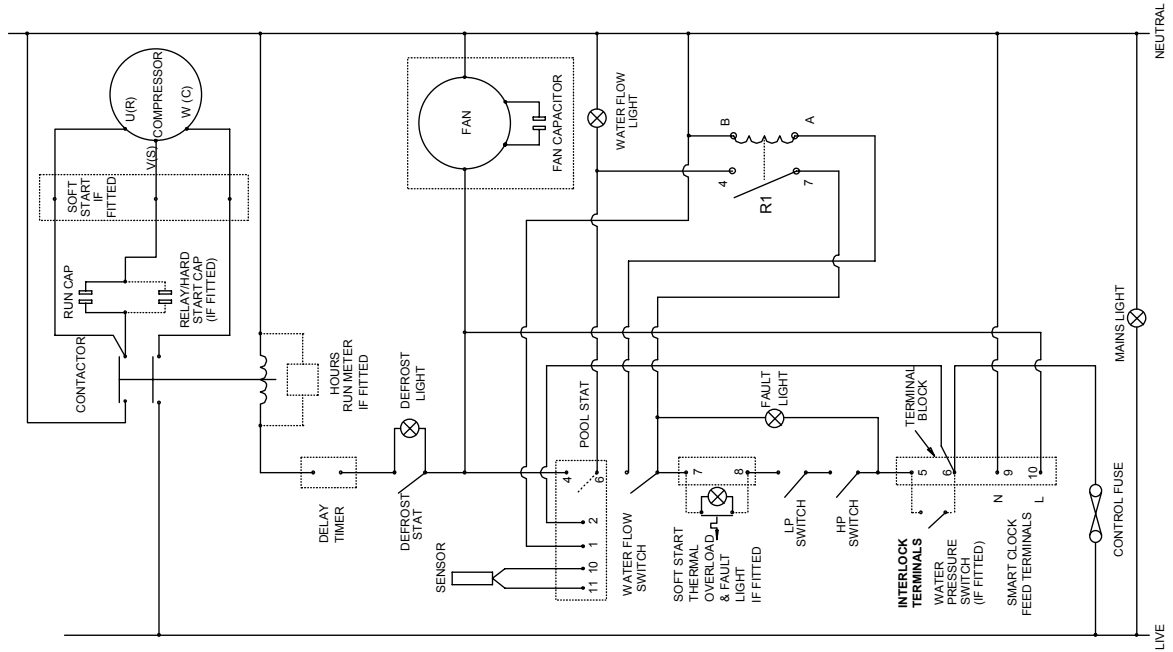

AW 631, 831, 1231 1531BL THREE PHASE (400V ~ 3 N 50Hz)

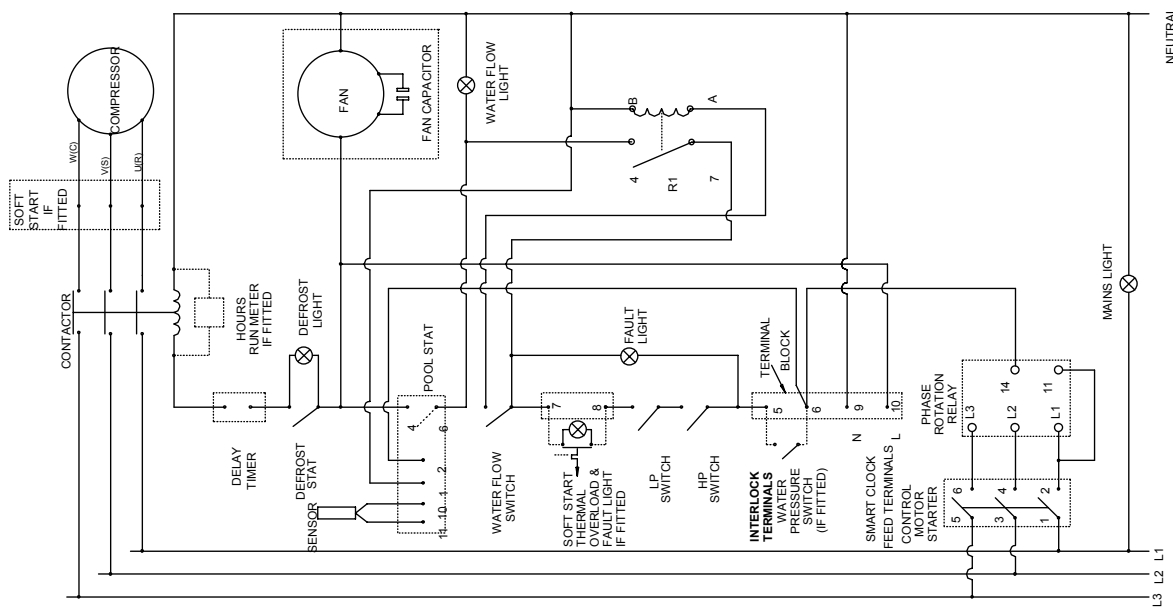

AW631, 831, 1231 ALY SINGLE PHASE (230V ~ 1 N 50Hz)

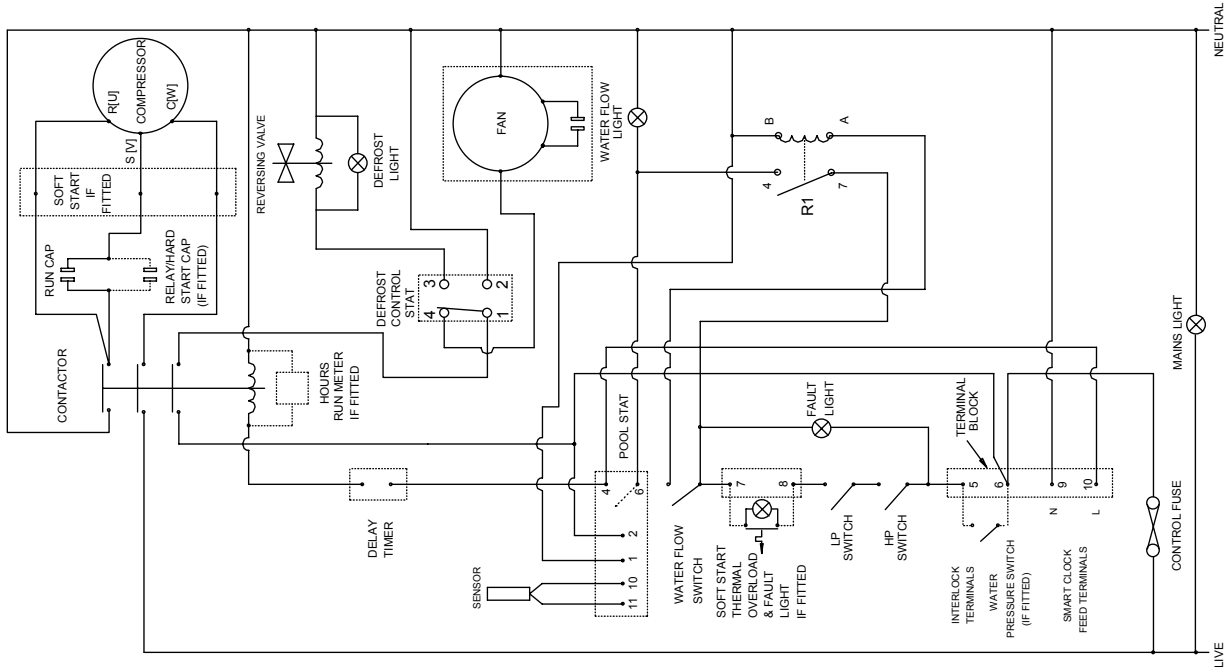

AW 631, 831, 1231 1531BLY THREE PHASE (400V ~ 3 N 50Hz)

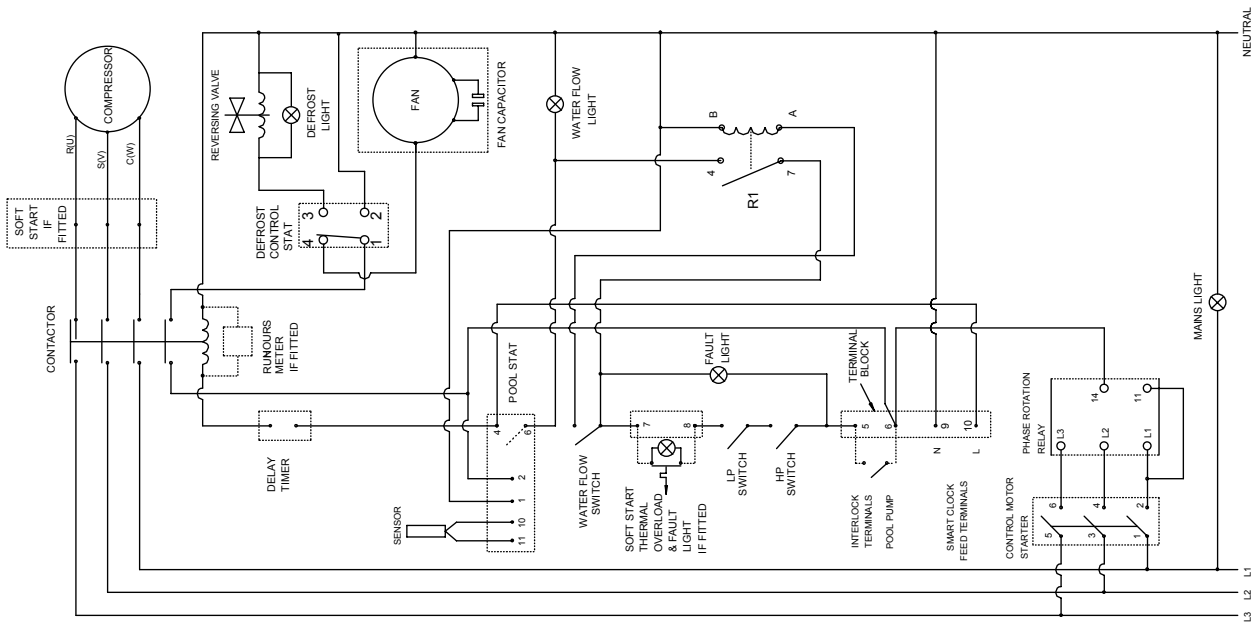

CONTROLS AND INDICATION LAMPS



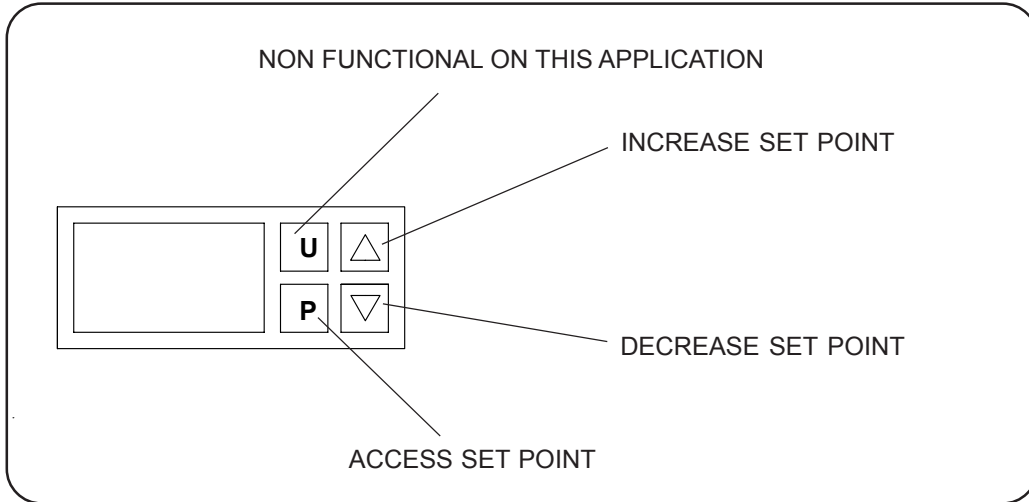

THERMOSTAT

Adjustable digital thermostat, controls pool water temperature at the required level.

Press and release key 'P' to display required temperature, to alter required temperature press up or down symbols. After 5 seconds display will revert to actual water temperature.



INDICATOR LAMPS "AW" POOL HEATERS

	MAINS	RED	Electrical supply on
	FAULT	AMBER	Internal or external fault condition
	DEFROST	WHITE	Defrost Mode
	WATER FLOW	GREEN	Water flowing at adequate rate

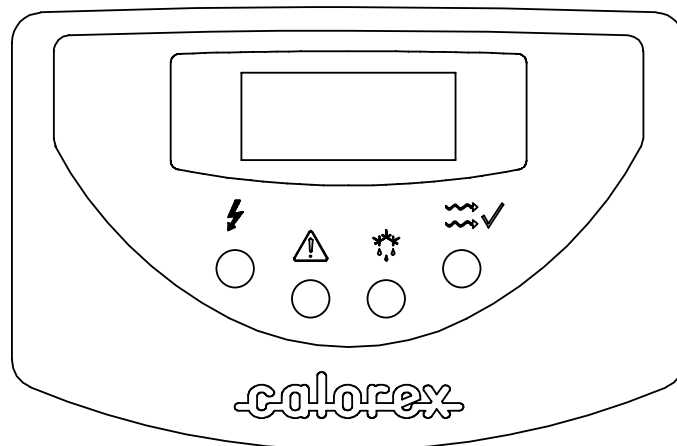

CONSOLE LABEL

HEAT PUMP MALFUNCTION

WARNING: Isolate machine electrically before entering machine or removing panels.

























The user check list should be carried out before initiating a service call.

Do not attempt to interfere with any internal control settings as these have been factory calibrated and sealed.

If in doubt or if advice required contact Calorex Service Department.

Telephone (01621) 857171 or 856611

USER CHECK LIST

LAMP				ACTION
UNIT DOES NOT OPERATE				
MAINS	RED		OFF	} Check mains supply- external fuses - isolator etc.
FAULT	AMBER		OFF	
DEFROST	WHITE		OFF	
WATER FLOW	GREEN		OFF	
MAINS	RED		ON	} Water flow inadequate
FAULT	AMBER		OFF	
DEFROST	WHITE		OFF	
WATER FLOW	GREEN		OFF	
MAINS	RED		ON	} First check water flow, then Check unit control fuse on single phase machine. Check MCB on three phase machine.
FAULT	AMBER		OFF	
DEFROST	WHITE		OFF	
WATER FLOW	GREEN		OFF	
MAINS	RED		ON	} Check water and air flows are not restricted. Check thermal cut out on Soft Start if fitted and that air flow is not restricted. Check unit control fuse on single phase machine. Check MCB on three phase machine.
FAULT	AMBER		ON	
DEFROST	WHITE		OFF	
WATER FLOW	GREEN		OFF	
FAN ON COMPRESSOR OFF				
MAINS	RED		ON	} Unit on defrost (heating mode) check that air temperature is not below 7°C.
FAULT	AMBER		OFF	
DEFROST	WHITE		ON	} Check evaporator is clean.
WATER FLOW	GREEN		ON	
UNIT OPERATES INTERMITTENTLY				
MAINS	RED		ON	} Check water and air flows are not restricted, and that electrical supply is adequate.
FAULT	AMBER		ON/OFF	
DEFROST	WHITE		OFF	} Check gas charge and airflow to machine.
WATER FLOW	GREEN		OFF	

DATA SHEET

HEAT PUMPS FOR OUTDOOR POOLS SUMMER SEASON (AL, BL)

MODEL	Units	AW631	AW831	AW1231	AW1531
HEAT TO POOL WATER					
AMBIENT 10°C, WATER 24°C	kWhr	7.2	9.9	12.4	17.7
AMBIENT 20°C, WATER 24°C	kWhr	9.2	12.5	15.6	22.4
ELECTRICITY					
ELECTRICAL SUPPLY 1 PHASE		----- 230V/~1N/ 50Hz -----			
ELECTRICAL SUPPLY 3 PHASE		----- 400V/~3N/ 50Hz -----			
TOTAL POWER CONSUMED					
AMBIENT 10°C, WATER 24°C	kWhr	1.8	2.3	3.1	4.2
AMBIENT 20°C, WATER 24°C	kWhr	2.0	2.5	3.3	4.3
MIN SUPPLY CAPACITY (Max F.L.A.) 1 ph N:-	A	14.3	17.4	19.0	N/A
MIN SUPPLY CAPACITY (Max F.L.A.) 3 ph N:-	A	6.0	6.2	8.0	13.0
MAX SUPPLY FUSE 1 ph N:-	A	20.0	25.0	30.0	N/A
MAX SUPPLY FUSE 3 ph N:-	A	10.0	10.0	15.0	18.0
WATER FLOWS ETC					
POOL WATER FLOW RATE:-	l/mn	115	115	160	160
POOL WATER PRESSURE DROP (@ Rated Flow):-	m hd	1.1	1.1	2.9	2.9
MAX WORKING PRESSURE POOL WATER:-	bar	3.5	3.5	3.5	3.5
POOL WATER CONNECTIONS:-	inches	1 1/2" BSPM	1 1/2" BSPM	1 1/2" BSPM	1 1/2" BSPM
CONDENSATE DRAIN CONNECTIONS:-	inches	3/4"BSPM STUD	3/4"BSPM STUD	3/4"BSPM STUD	3/4"BSPM STUD
COMPRESSOR					
NOMINAL POWER CONSUMED	kWhr	1.8	2.14	2.6	3.8
L.R.A. 1 ph N:-	A	66	63	100	N/A
R.L.A. 1 ph N:-	A	11.4	14	16.6	N/A
SOFT START AMPS 1 ph N:-	A	29	31	35	N/A
L.R.A. 3 ph N:-	A	32	30	48	48
R.L.A. 3 ph N:-	A	4	4.7	7.3	10
SOFT START AMPS 3 ph N:-	A	14	14	17	25
MAIN FAN					
AIR FLOW (Anemometer @ air on grille. Wet evaporator):-	m³/hr	1800	2700	3000	4700
MAX EXTERNAL STATIC PRESSURE:-	mm Wg	0	0	0	0
F.L.A. 1 ph N:-	A	0.7	0.7	0.97	2
GENERAL DATA					
HERMETIC SYSTEM					
GAS CHARGE R407c	kg	1.6	2.05	2.2	2.45
PHYSICAL DIMENSIONS					
WIDTH (Unpacked):-	mm	1076	1076	1076	1200
DEPTH (Unpacked):-	mm	485	485	485	485
HEIGHT (Unpacked):-	mm	1255	1255	1355	1355
WEIGHT (Unpacked):-	kg	126	134	144	158

For Accurate Application Sizing Consult CALOREX Heat Pumps Ltd.

NOTES:-

- 1) Weight and dimensions nett
- 2) Performance design limitations
Ambient = 7°C min, 40°C max
Water = 10°C min, 40°C max
- 3) Pool water to have correct balance, pH 7.4 ± 0.4 Free Chlorine 1.0 - 3.0 ppm
- 4) Allow 500mm clearance to service panels
- 5) Calorex reserve the right to change or modify models without prior notice.
- 6) R407c Global warming potential (GWP) 1700.
1mm WG = 9.8 Pa
1m hd = 1.4 psi
1L/min = 0.22 gall/min

HEAT PUMPS FOR OUTDOOR POOLS REVERSE CYCLE DEFROST (ALY, BLY)

MODEL	Units	AW631	AW831	AW1231	AW1531
HEAT TO POOL WATER					
AMBIENT 10°C, WATER 24°C :-	kWhr	7.2	9.9	12.4	17.7
ELECTRICAL					
ELECTRICAL SUPPLY 1 PHASE		----- 230V~1N/50Hz -----			
ELECTRICAL SUPPLY 3 PHASE		----- 400V~3N/50Hz -----			
TOTAL POWER CONSUMED:-					
AMBIENT 10°C, WATER 24°C :-	kWhr	1.8	2.3	3.1	4.2
AMBIENT 20°C, WATER 24°C :-	kWhr	2.0	2.5	3.3	4.3
MIN SUPPLY CAPACITY (Max F.L.A.) 1 ph N:-	amps	14.3	17.4	19.0	N/A
MIN SUPPLY CAPACITY (Max F.L.A.) 3 ph N:-	amps	6.0	6.2	8.0	13.0
MAX SUPPLY FUSE 1 ph N:-	amps	20.0	25.0	30.0	N/A
MAX SUPPLY FUSE 3 ph N:-	amps	10.0	10.0	15.0	18.0
WATER FLOWS ETC					
POOL WATER FLOW RATE:-	litres/min	115	115	160	160
POOL WATER PRESSURE DROP (@ Rated Flow):-	metres hd	1.0	1.0	2.0	2.0
MAX WORKING PRESSURE POOL WATER:-	bar	3.5	3.5	3.5	3.5
POOL WATER CONNECTIONS:-	inches	1 1/2" BSPM	1 1/2" BSPM	1 1/2" BSPM	1 1/2" BSPM
CONDENSATE DRAIN CONNECTIONS:-	inches	3/4" BSPM STUD	3/4" BSPM STUD	3/4" BSPM STUD	3/4" BSPM STUD
COMPRESSOR					
NOMINAL POWER CONSUMED:-	kWhr	1.8	2.14	2.6	3.8
LRA- 1 ph N:-	amps	66	63	100	N/A
RLA- 1 ph N:-	amps	11.4	14	16.6	N/A
SOFT START AMPS 1 ph N:-	amps	29	31	35	N/A
LRA- 3ph N:-	amps	32	30	48	48
RLA- 3 ph N:-	amps	4	4.65	7.3	10
SOFT START AMPS 3 ph N:-	amps	14	14	17	25
MAIN FAN					
AIR FLOW (Anemometer @ air on grille. Wet evaporator):-	m ³ /hr	1800	2700	3000	4700
MAX EXTERNAL STATIC PRESSURE :-	mm Wg	0	0	0	0
FLA- 1 ph N:-	amps	0.7	0.7	0.97	2
GENERAL DATA					
HERMETIC SYSTEM					
GAS CHARGE R407c	kg	2.31	3.0	4.5	4.5
PHYSICAL DIMENSIONS					
WIDTH (Un-packed):-	mm	1076	1076	1076	1200
DEPTH (Un-packed):-	mm	485	485	485	485
HEIGHT (Un-packed):-	mm	1255	1255	1355	1355
WEIGHT (Un-packed):-	kg	133	142	157	170

For Accurate Application Sizing Consult CALOREX Heat Pumps Ltd.

NOTES:

- 1) Weight and dimensions nett
- 2) Performance design limitations
Ambient = -15°C min, 35°C max
Water = 10°C min, 40°C max
- 3) Pool water to have correct balance, pH 7.4 ± 0.4 Free Chlorine 1.0 - 3.0 ppm
- 4) Allow 500mm clearance to service panels
- 5) Calorex reserve the right to change or modify models without prior notice.
- 6) R407c Global Warming Potential (GWP) 1700.
1mm WG = 9.8 Pa
1m hd = 1.4 psi
1L/min = 0.22 gall/min

INSTALLATION DRAWINGS

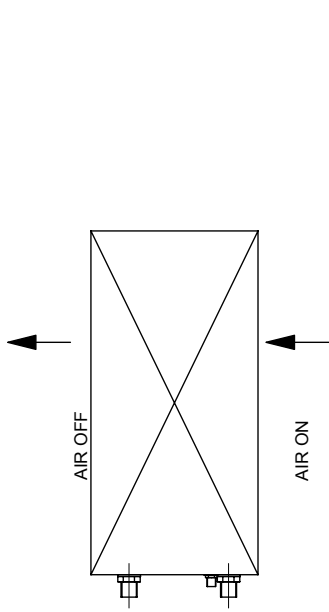

AW631
 WATER IN/OUT 1 1/2" BSPM STUBS
 CONDENSATE 3/4" BSPM

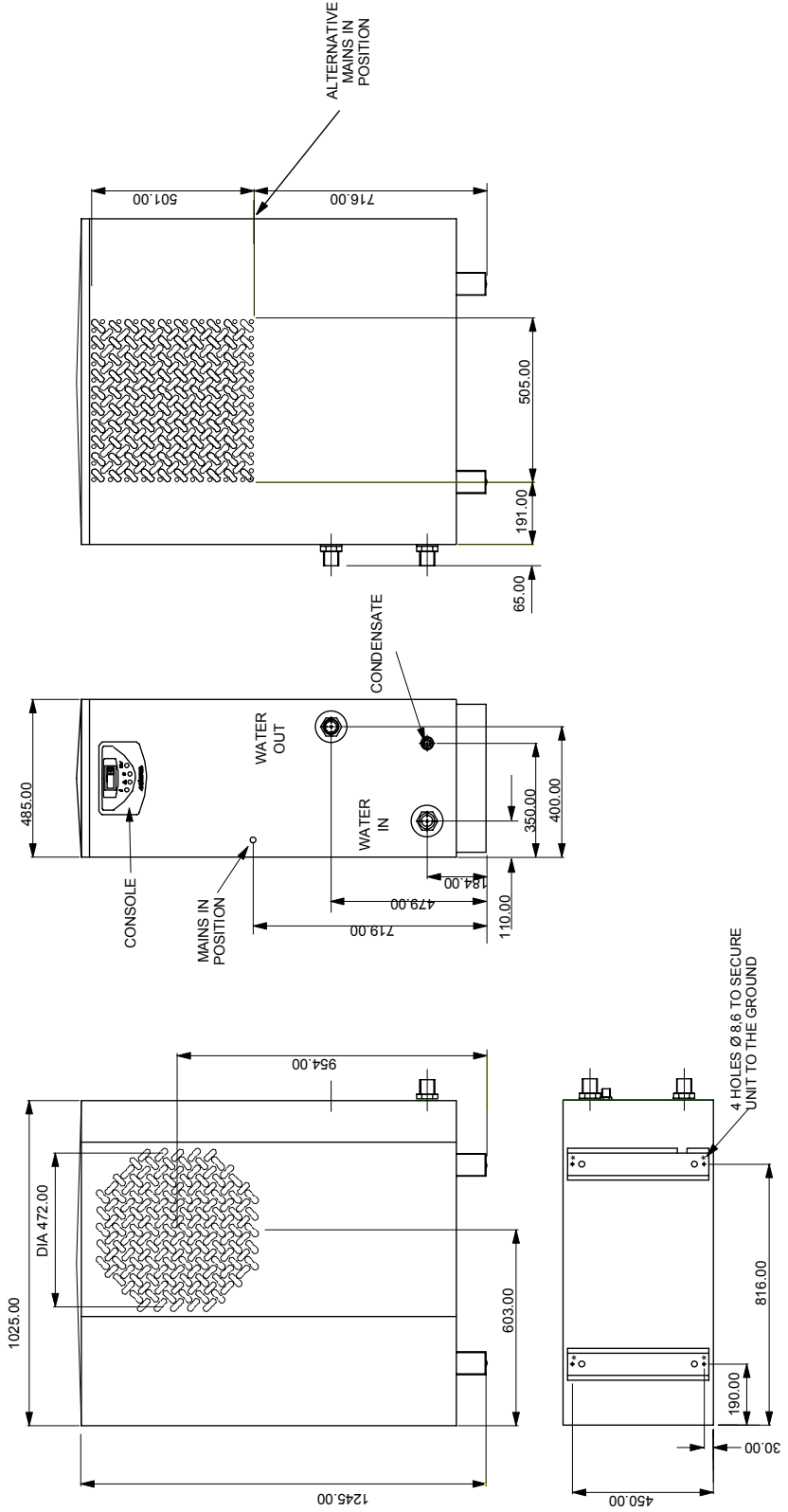

AW1231
 WATER IN/OUT 1 1/2" BSPM STUBS
 CONDENSATE 3/4" BSPM

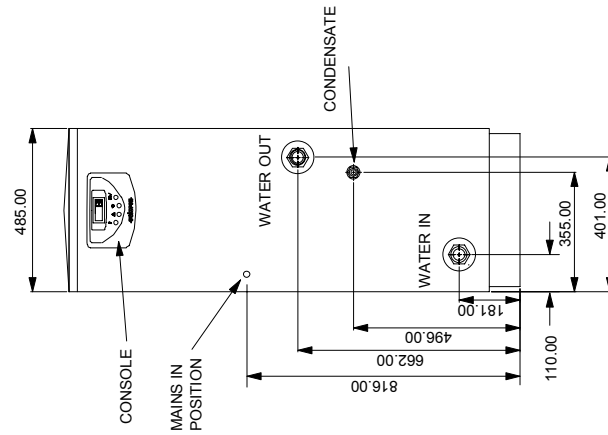
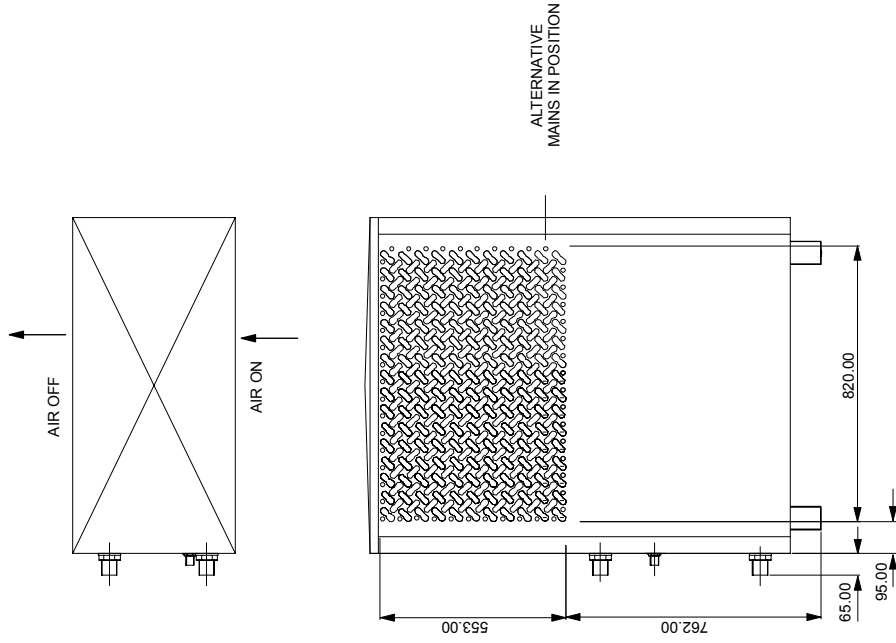
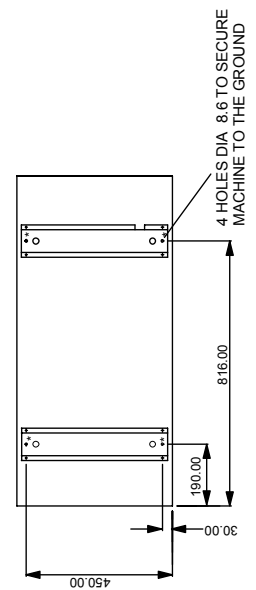
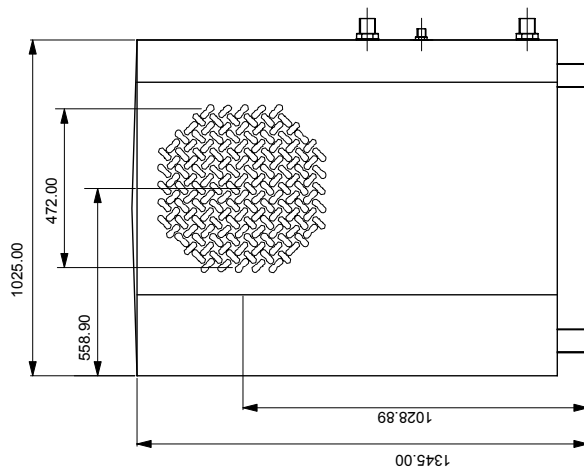

AW1531
 WATER IN/OUT 1 1/2" BSPM STUBS
 CONDENSATE 3/4" BSPM STUB

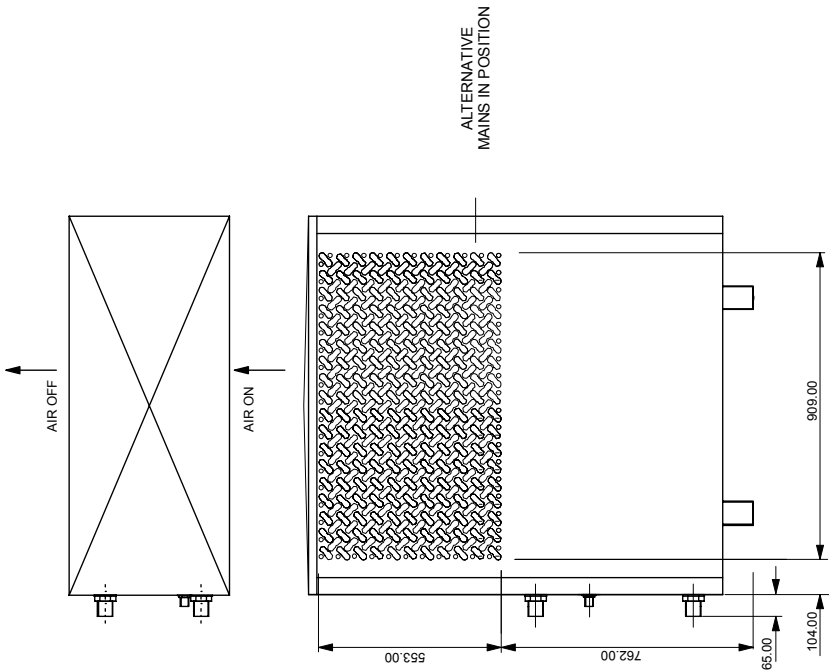
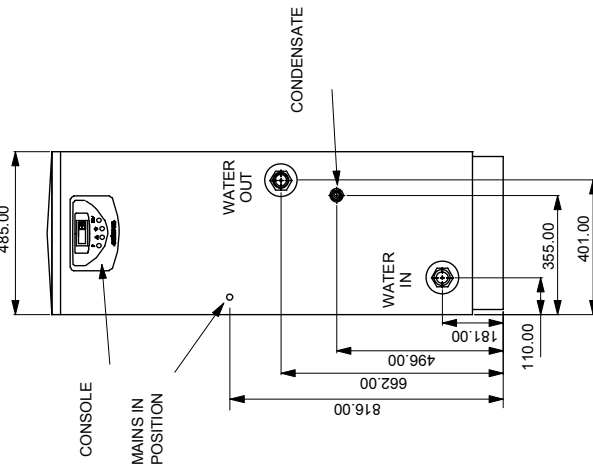
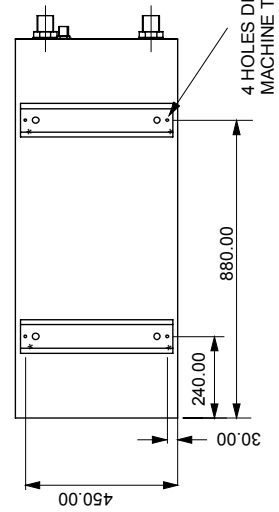
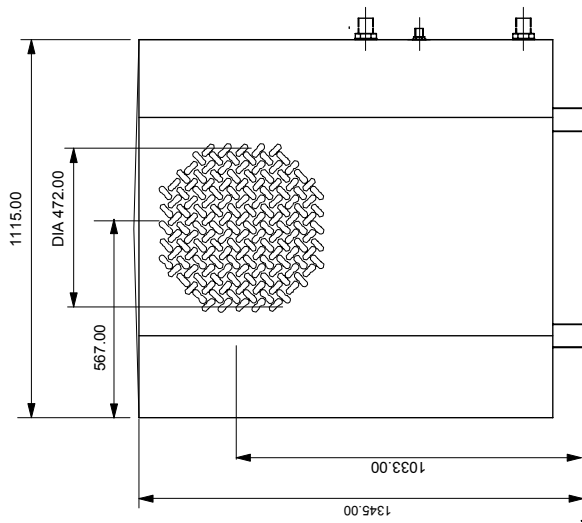

WINTERISING PROCEDURE

WARNING. Isolate machine before removing covers! The heat pump embodies electrical and rotational equipment, it is recommended for your own safety that a competent person carries out the following procedure

ALL MODELS

Objective

To provide frost protection

To eliminate corrosion problems

To inhibit electrical components

1. Switch off electric supply to heat pump.
2. Remove external fuses and keep in safe place away from heat pump to prevent accidental operation of heat pump.
3. Ensure water circulation pump is switched off.
4. Drain water from heat pump by:
 - a. drain valve if fitted
 - b. disconnecting pipework to and from heat pump
5. Flush through water circuit in heat pump by using CLEAN TAP WATER (NOT POOL WATER) via hose into outlet connection - run the hose for 10 minutes minimum; use spray nozzle if available.
6. Allow to drain - when drained, fit plastic bags secured by elastic bands over water connections.
7. Uncover electrical enclosure (see page 12) and liberally spray interior of unit, with moisture-repellant aerosol WD40 or similar; reseal enclosure.
8. If heat pump located outside, protect from weather by covering with VENTILATED cover. Do not use plastic sheet as condensation could occur within unit.

N.B. If this procedure is not adopted and frost or corrosion damage results then the warranty will become invalid.

START UP PROCEDURE AFTER WINTERISATION

1. Replace covers (if not fitted).
2. Remove front grille .Using a soft brush clean finned surfaces of heat pump. Replace panel.
3. Remove plastic covers on water connections and reconnect water piping or close drain valve.
4. Start up water circulating pump and leave running for at least 1/4 hour to establish flow and enable any air in piping to escape.
5. Replace fuses to heat pump circuit.
6. Switch on heat pump.
7. Check control thermostat is set to required pool temperature.
8. Check pool water daily to ensure it is at correct pH and has correct chemical balance. See Section 3 Plumbing.

WARRANTY CONDITIONS.

The following exclusions apply to the Warranty given by Calorex Heat Pumps Ltd. No claims will be accepted if : -

1. The heat pump is incorrectly sized for the application.
2. The heat pump is installed in any way that is not in accordance with the current procedures as defined by Calorex Heat Pumps Ltd.
3. The heat pump has been worked upon or is adjusted by anyone other than a person authorised to do so by Calorex Heat Pumps Ltd.
4. The air flow to and from the machine is outside the specified limits.
5. The water flow through the machine is outside the specified limits.
6. The water pH level and/or chemical balance is outside the following limits:-

Acidity	pH:	7.4 ± 0.4
Total Alkalinity, as CaCO ₃	ppm	80 -120
Total Hardness, as CaCO ₃	ppm	100-300
Total Dissolved Solids:	ppm	MAX 3000
Maximum Salt Content:	wt/wt	6%
Free Chlorine Range:	ppm	1.0 - 3.0
Superchlorination:	ppm	MAX 30 for MAX 24hrs
Bromine:	ppm	2-3
Baquacil:	ppm	25 - 50
Ozone:	ppm	0.8 - 1.0
*Maximum Copper Content:	ppm	MAX 2
*Aquamatic Ionic Purifier:	ppm	MAX 2
*Tarn Pure Purifier:	ppm	MAX 2
*Sherwood Purifier:	ppm	MAX 2

7. The heat pump has suffered frost damage.
8. The electrical supply is insufficient or in anyway incorrect.

CONTACTING CALOREX

IF IN ANY DOUBT PLEASE ASK

Note:- The Reply Paid Warranty Registration Card must be returned, to ensure that the correct warranty is given. If you do not find a Registration Card with your Heat Pump please contact the Calorex Service Department giving your name, address and serial number of your heat pump. A card will be sent to you for completion.

Email: service@calorex.com

01621 857171



Website: <http://www.calorex.com>

01621 856611

Please give MODEL NUMBER and SERIAL NUMBER of your heat pump when making technical or service enquiries. This will assist in correct diagnosis and ensure service can be provided with the minimum delay