

iSAVER+ Frequency Inverter for Swimming Pool Pumps

DVSD03, DVSD04



HeatPumps
4Pools 

IMPORTANT:

READ CAREFULLY BEFORE USE. KEEP FOR FUTURE REFERENCE.

Notice to Installer:

This document contains important information about the installation, operation and safe use of this product – this information must be read before the installation and start-up of this product. **Once the product has been installed this document must be given to the owner/operator of this equipment.**



Certikin
FLUIDRA

Table of contents

Content:	Page No:
Product conformity information	2
Safety notices	2
About the product	3-4
List of supplied components	4
Installation	4-5
Settings & operation	6-8
Maintenance	8
Troubleshooting / protection & error codes	9







Product conformity information

This product complies with:

- Low Voltage Directive (LVD) 2014/35/EU
- Electromagnetic Compatibility (EMC) Directive 2014/30/EU
- Restriction of Hazardous Substances (RoHS) Directive 2011/65/EU

Safety notices

TO AVOID POSSIBLE HARM, READ AND FOLLOW THESE INSTRUCTIONS

 <p>DANGER</p> <p>This notice signifies a hazard with a HIGH level of risk which, if not avoided, WILL result in death or serious injury.</p>	 <p>WARNING</p> <p>This notice signifies a hazard with a MEDIUM level of risk which, if not avoided, COULD result in death or serious injury.</p>
 <p>DANGER</p> <p>This notice signifies an ELECTRICAL hazard with a HIGH level of risk which, if not avoided, WILL result in death or serious injury.</p>	 <p>WARNING</p> <p>This notice signifies An ELECTRICAL hazard with a MEDIUM level of risk which, if not avoided, COULD result in death or serious injury.</p>
 <p>CAUTION</p> <p>This notice signifies a hazard with a LOW level of risk which, if not avoided, COULD result in minor or moderate injury.</p>	 <p>NOTICE</p> <p>This notice signifies a potential risk of damage to the product or property.</p>
 <p>CAUTION</p> <p>Do not touch the heat sink during operation.</p>	

About the product

The iSAVER+ swimming pool pump frequency inverter is designed to allow the user to control and vary the operational speed of the swimming pool pump in order to gain energy and cost saving efficiencies.

The product benefits from multiple time and speed settings, which can be used manually or automated through timers. The easy to read display shows current operational settings and also provides power usage information for the setting in use.

Two models are available: DVSD03 (Inverter output 1.1kW) for pumps up to 1HP, and DVSD04 (Inverter output 2.2kW) for pumps up to 2HP – **ENSURE YOU ARE USING THE CORRECT MODEL.**

⚠ WARNING This device is designed for use **ONLY** with swimming pool pumps with a permanent split capacitor motor. Fig 1 below shows a wiring schematic for a typical single speed swimming pool pump motor

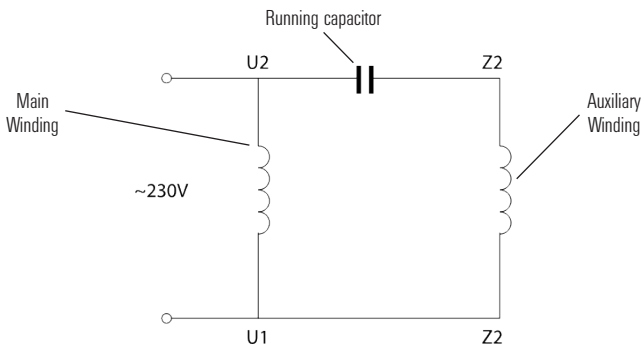

Fig 1: Typical single speed swimming pool pump motor schematic

⚠ WARNING This device **IS NOT COMPATIBLE WITH:**

- a) Single phase motors with centrifugal switch
- b) Motors with start relays or switches
- c) Series or DC motors
- d) Motors with faults in their rotors or capacitors
- e) Shaded-pole asynchronous motors

⚠ WARNING An RCD with a rated residual current not exceeding 30Ma must be used with this device.

If you are unsure of the compatibility of your swimming pool pump with this device, please contact your pump supplier before proceeding.

Technical data

	DVSD03	DVSD04
Input Power	1 phase AC	
Input Voltage	220-240V	
Input Frequency	50Hz	
Output Power	Max 1.1kW	Max 2.2kW
Output Voltage	1ph, 0-240V	
Phase Type	Single phase	
Max. Current	Max 6A	Max. 12A
Speed Range	1200-2900rpm	
Cooling	Ventilation	Ventilation + Fan
Gross / Net Weight	3.0 / 2.7kg	
Dimensions (HxWxD)	206x110x155mm	

Once expired, this product should not be disposed of via general waste, but through a regulated waste disposal and recycling centre – please consult your local authority for full advice.

List of supplied components

- iSaver+ inverter
- Power supply cable (pre-wired into inverter)
- Mounting template, fixings screws and plugs

Installation

⚠ WARNING Upon receipt of this device, check for any damage which may have occurred in transit. If any damage is found, **DO NOT PROCEED WITH INSTALLATION** and contact your supplier for advice.

⚠ WARNING Do not power this device by means of an extension lead.

⚠ WARNING A qualified electrician must carry out all electrical wiring in accordance with local electrical regulations.

Locating the device

The choice of location for the device must meet the following condition:

- Indoors
- Ambient temperature of -10 to +40°C
- Less than 1000m above sea level
- Out of direct sunlight
- Good ventilation (see below)

For efficient cooling, ensure the unit is installed with a *minimum* clearance around it of 40cm above and below and 25cm at either side, as per Fig 2.

⚠ WARNING Blocked ventilation or an enclosed space with limited air flow may cause overheating or potential operational failure of the inverter.

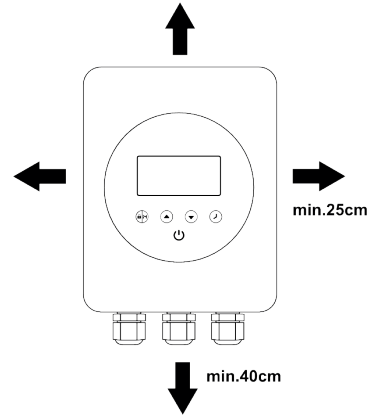

Fig 2: Spacing around the iSaver+ inverter

Connecting to the pump

⚠ NOTICE Please follow these instructions for pump connection. Incorrect connection will void the warranty.

⚠ WARNING Only ONE swimming pool pump can be connected to this device – do not attempt to connect multiple devices. Do not connect anything other than a swimming pool pump to the output of this device.

Using the template supplied, mark hole locations on the wall where the inverter is to be mounted. Drill holes and use the plugs and fixings supplied to create the mounting position for the unit. Test mount and then remove.

From the rear of the inverter, remove the recessed screws which hold the outer cover to the body. Carefully lift and remove the outer cover in order to gain access to the internal terminal connections.

⚠ WARNING A qualified electrician must carry out all electrical wiring in accordance with local electrical regulations.

If currently installed, turn off the full electrical supply to the swimming pool pump. Unwire the pump and make a connection, through the cable glands, to the correct terminals within the inverter as shown in Fig. 3. Ensure all terminal connections are well made and tight.

Connect the pre-wired power cord from the inverter to the power source, via an RCD with a rated residual current not exceeding 30Ma (this will very probably be the power source that the pump was originally connected to).

Carefully reconnect the outer cover of the inverter and mount it onto the fixing screws. The electrical supply can now be reinstated and the inverter is ready for use.

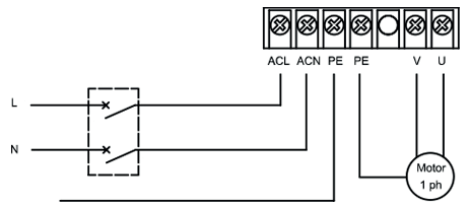

Fig 3: Terminal connections within the inverter.

Settings & operation

⚠ CAUTION Do not touch the heat sink whilst the device is operating, or until 30 minute after the device has been switched off. It is normal for the heat sink to get hot during standard operation.

Display control panel contents

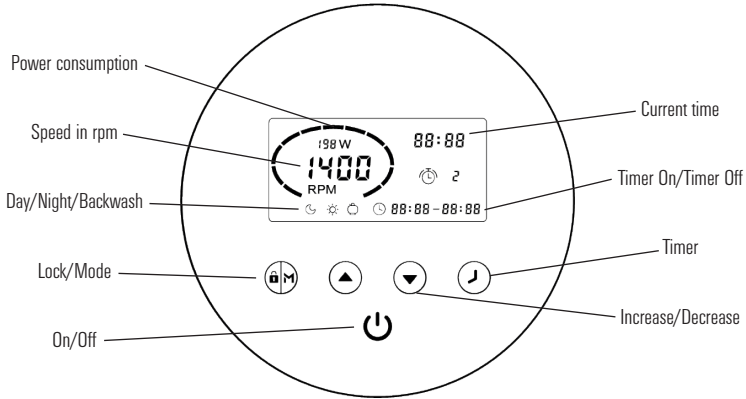

Fig 4: Display control panel contents

Pre-set modes

The iSaver+ includes three pre-set modes (speed ranges) as shown in the table below. The pool pump can be run at a constant speed by choosing one of these modes via the 'M' function, or it can be run via the setting up of four timers for daily operation, each with an individual speed.

Mode (M)	Speed Range	Default Speed
Night (slow)	1200-1650rpm	1400rpm
Day (medium)	1700-2400rpm	2000rpm
Backwash (high)	2450-2900rpm	2900rpm

Useful notes on general operation

If inactive for 1 minute, the screen will lock automatically. Hold  for 3 seconds to unlock the device.

The device has a 'power off memory'. In the event of power interruptions settings will be retained and resume upon power restoration.



To restore factory settings, with the unit OFF, hold   together for 3 seconds.

Initial operation

When first powered up,  will illuminate. Hold  for 3 seconds in order to unlock the screen.

Press  to start the inverter.

Upon starting, the pump will run at maximum speed of 2900rpm for one minute in order to ensure priming. This can be increased to up to 10 minutes if required – see 'Parameter Settings' on page 8.

Press  to choose a running speed. Use the  and  buttons to adjust the speed in 50rpm increments in order to set a specific running speed if required.

Once the pump has finished priming, the inverter will automatically adjust the pump speed to the pre-set value.

 shows that the pump is running and at which current speed (rpm). Power consumption in Watts (W) is shown for that particular speed.







Timer setting

Running the pump at different speeds at different times of the day will minimise energy consumption when higher speeds are not needed and can allow the user to take advantage of lower electricity tariffs, for example during the night.

In order to benefit from this, the iSaver+ allows the setting of up to 4 timers. These are established as follows.



Step 1: Press  to begin using the timer function

Step 2: Use  and  to set the current clock time.

Step 3: Press  to toggle to timer 1 and use  and  to set the start times for that timer. Use  to toggle to the stop times, use  and  to set that time. Use  to toggle to the speed setting.

Note: Each setting is saved as you 'toggle' through with the  button.



Step 4: When the time is set, press  to choose a pre-set speed range for that timer 1, or use  and  to decide on a specific speed if required.

NOTE: Pressing   together will move the cursor to the *previous* setting.

Step 5: Repeat steps 3 and 4 to set the remaining times.

Step 6: Hold  for 3 seconds, or wait 10 seconds to save the timer settings automatically.

NOTE: When  **88:88-88:88** is flashing, this means that the device is waiting for a start time.

Step 7: Press  or  to check all 4 timers and ensure there are no invalid settings. Any overlapping of timer periods will be considered as invalid and the device will only run based on the previous valid timer setting.

NOTE: During timer setting, if you want to abandon the process, hold  for 3 seconds.

External control

External control can be enabled via the contact shown in Fig. 5 below. However, even if the device is working via an external controller, pressing  can stop the device.

For example – to enable external speed control via digital input, connect one of the digits from Di2/3/4 to COM

⚠ NOTICE Do not apply voltage to these input contacts.

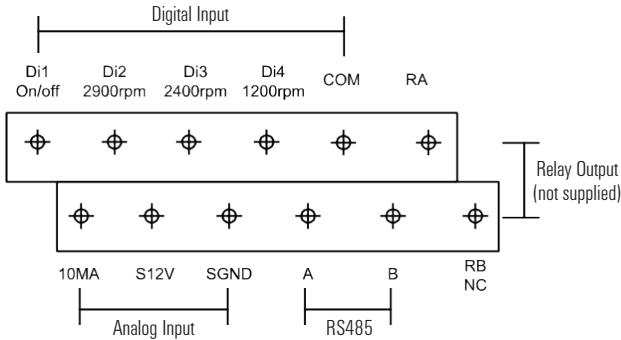

Fig. 5: External control inputs

Parameter settings

When turned OFF, hold   for 3 seconds to enter parameter settings.

Parameter	Description	Default Setting	Setting Range
1	Priming time	1 minute	1-10 minutes, by 1 minute increments
2	Minimum rpm	1200rpm	1200-2000rpm, by 100rpm increments

Maintenance

This device carries no serviceable or maintenance needing parts. In the event of a fault or failure which cannot be resolved via these instructions, please contact your supplier.

⚠ WARNING Because of high voltage conversion components contained within this device, do not try to disassemble the device or replace any components in the event of a malfunction or failure.

⚠ WARNING Before disconnecting the device from mains power, always wait until the power light has turned off OR wait at least three minutes after power has been disconnected – whichever is the longer.

Troubleshooting / protection & error codes

The device may show error codes in certain circumstances – these codes could signify a fault, or may be an alert to protect the device from damage.

Code	Description	Analysis / Action
E001	Abnormal input voltage	No fault – consult electrician
E002	Output over current	See note 1 or contact supplier
E101	Heat sink over heat	See note 1 or contact supplier
E102	Heat sink sensor error	Contact supplier
E103	Master drive board error	See note 1 or contact supplier
E201	Circuit board error	Contact supplier
E202	Master board EEPROM reading failure	Contact supplier
E203	RTC time reading error	Contact supplier
E204	Keyboard EEPROM reading failure	Contact supplier
E205	Communication error	Contact supplier
AL01	Auto speed reduction against high temperature	See note 2

Note 1: When the cause resulting in error code E002/E101/E103 lifts, the device will resume working correctly – however this pattern will only repeat for three occasions – on the fourth occasion the device will stop working. To resume operation, turn off all power, then re-establish power and re-start the unit. If problems persist contact your supplier for assistance.

Note 2: AL01 is not an error indication. When this code appears, the device will automatically switch to a lower speed to self-protect against internal high temperatures. When the temperature drops back to 65°C the inverter will resume at the pre-set speed.

Certikin International Ltd
Witan Park
Station Lane Industrial Estate
Witney
Oxfordshire
OX28 4FJ

Item manufactured by Aquagem Electric Limited, Guangzhou, China



 01993 777200  info@certikin.co.uk

www.certikin.co.uk

JANUARY 2020

Certikin
FLUIDRA